

机能符号/Functional Symbol

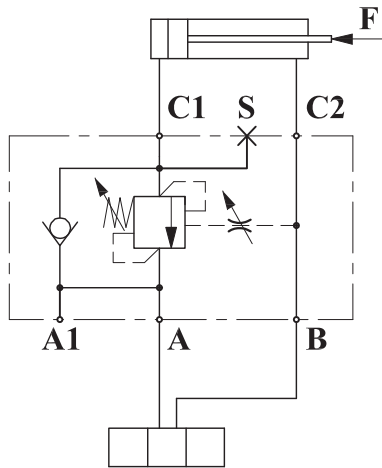

技术参数/Technical Data

- Matching directional valve neutral function A.B-T.  
建议应用Y型中位机能的换向阀
- Operating temperature: +40°C~+70°C  
工作温度: +40°C~+70°C
- Working medium: ISO VG 10 to 68 according to DIN ISO 3448  
工作介质: 符合DIN ISO 3448标准, 范围在ISO VG 10-68
- Material: Steel, zinc-plated  
阀体材质: 镀锌钢体
- Sealing Material: Nitrile Rubber  
密封材质: 丁腈橡胶

主要尺寸/Dimension

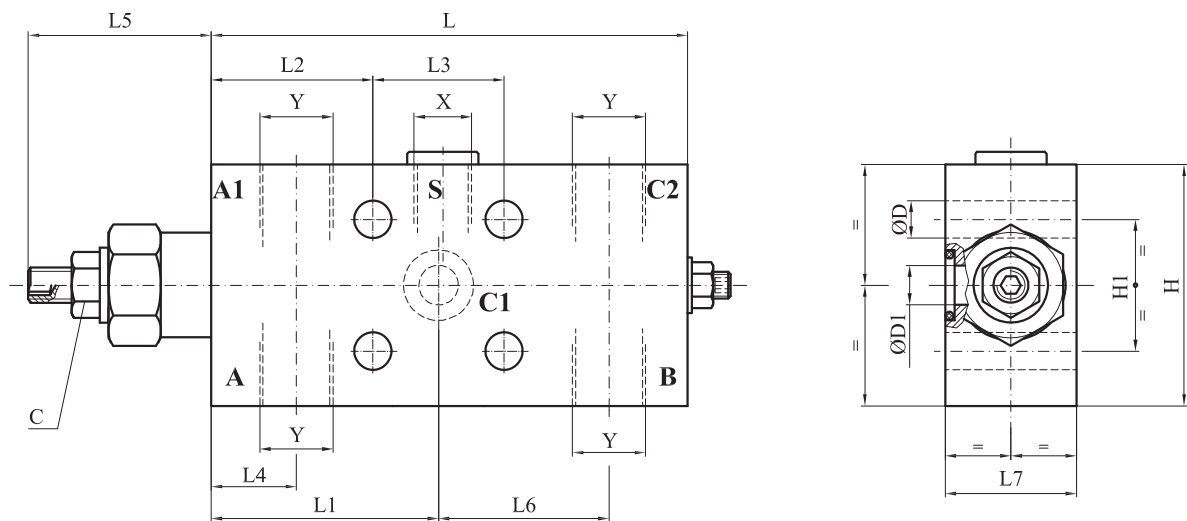

109	52	37	30	19.5	~42	39	30	55	30	HEX13	Ø8.5	Ø9	G1/4	G1/4	1.45Kg
109	52	37	30	19.5	~42	39	30	55	30	HEX13	Ø8.5	Ø9	G1/4	G3/8	1.4Kg
109	52	37	30	19.5	~42	39	35	65	30	HEX13	Ø8.5	Ø9	G1/4	G1/2	1.6Kg
L	L1	L2	L3	L4	L5	L6	L7	H	H1	C	D	D1	X	Y	重量 Weight